



5SDD 08D5000

Old part no. DV 827-800-50

Rectifier Diode

Properties

- low forward voltage drop
- low recovery charge
- high operating temperature
- low leakage current

Applications

- Rectifier bridges

Key Parameters

V_{RRM}	=	5 000	V
I_{FAVm}	=	1 028	A
I_{FSM}	=	12 000	A
V_{TO}	=	0.894	V
r_T	=	0.487	m Ω

Types

	V_{RRM}
5SDD 08D5000	5 000 V
Conditions:	$T_j = -40 \div 160 \text{ }^\circ\text{C}$, half sine waveform, $f = 50 \text{ Hz}$

Mechanical Data

F_m	Mounting force	$10 \pm 2 \text{ kN}$
m	Weight	0.27 kg
D_s	Surface creepage distance	30 mm
D_a	Air strike distance	20 mm

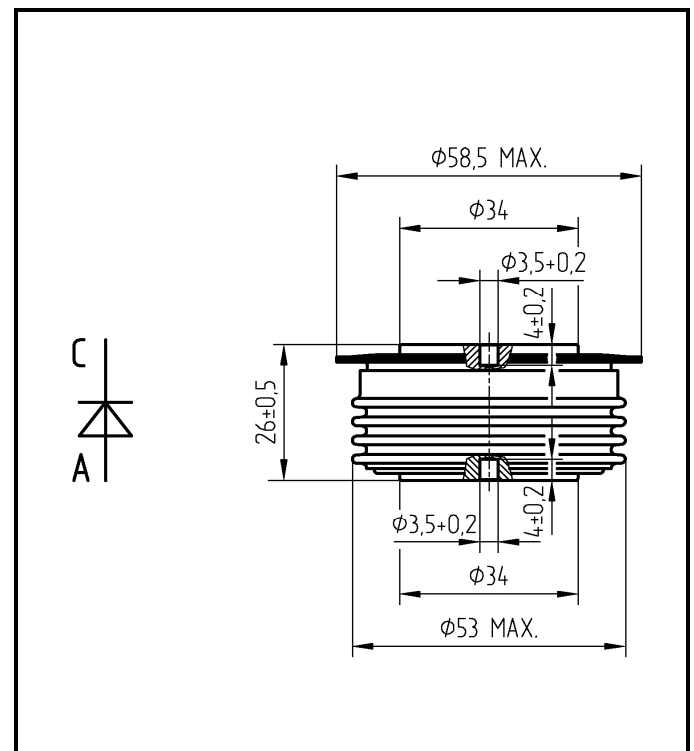

Fig. 1 Case



ABB s.r.o.

Novodvorska 1768/138a, 142 21 Praha 4, Czech Republic

tel.: +420 261 306 250, <http://www.abb.com/semiconductors>

Maximum Ratings		Maximum Limits	Unit	
V_{RRM}	Repetitive peak reverse voltage $T_j = -40 \div 160 \text{ }^\circ\text{C}$	5 000	V	
I_{FAVm}	Average forward current $T_c = 85 \text{ }^\circ\text{C}$	1 028	A	
I_{FRMS}	RMS forward current $T_c = 85 \text{ }^\circ\text{C}$	1 614	A	
I_{RRM}	Repetitive reverse current $V_R = V_{RRM}$	30	mA	
I_{FSM}	Non repetitive peak surge current $V_R = 0 \text{ V, half sine pulse, } T_j = 25 \text{ }^\circ\text{C}$	$t_p = 8.3 \text{ ms}$	16 000	A
		$t_p = 10 \text{ ms}$	15 000	A
	Non repetitive peak surge current $V_R = 0 \text{ V, half sine pulse}$	$t_p = 8.3 \text{ ms}$	12 800	A
		$t_p = 10 \text{ ms}$	12 000	A
$\int I^2 dt$	Limiting load integral $V_R = 0 \text{ V, half sine pulse, } T_j = 25 \text{ }^\circ\text{C}$	$t_p = 8.3 \text{ ms}$	1 066 000	A²s
		$t_p = 10 \text{ ms}$	1 125 000	A²s
	Limiting load integral $V_R = 0 \text{ V, half sine pulse}$	$t_p = 8.3 \text{ ms}$	682 000	A²s
		$t_p = 10 \text{ ms}$	720 000	A²s
$T_{jmin} - T_{jmax}$	Operating temperature range	-40 \div 160	°C	
T_{STG}	Storage temperature range	-40 \div 160	°C	

Unless otherwise specified $T_j = 160 \text{ }^\circ\text{C}$

Characteristics		Value			Unit
		<i>min</i>	<i>typ</i>	<i>max</i>	
V_{T0}	Threshold voltage			0.894	V
r_T	Forward slope resistance $I_{F1} = 1\,500 \text{ A, } I_{F2} = 4\,500 \text{ A}$			0.487	mΩ
V_{FM}	Maximum forward voltage $I_{FM} = 1\,500 \text{ A}$			1.65	V
Q_{rr}	Recovered charge $V_R = 100 \text{ V, } I_{FM} = 1\,000 \text{ A, } di/dt = -30 \text{ A}/\mu\text{s}$		2 400	3 500	μC

Unless otherwise specified $T_j = 160 \text{ }^\circ\text{C}$

Thermal Parameters			Value	Unit
R_{thjc}	Thermal resistance junction to case	double side cooling	32	K/kW
		anode side cooling	50	
		cathode side cooling	88	
R_{thch}	Thermal resistance case to heatsink	double side cooling	8	K/kW
		single side cooling	16	

Transient Thermal Impedance													
Analytical function for transient thermal impedance $Z_{thjc} = \sum_{i=1}^5 R_i (1 - \exp(-t / \tau_i))$	i	1	2	3	4	5							
	τ_i (s)	0.7033	0.2185	0.0588	0.0042	0.0006							
	R_i (K/kW)	11.56	10.08	7.84	2.38	0.13							
Conditions: $F_m = 10 \pm 2$ kN, Double side cooled Correction for periodic waveforms													
<table border="1"> <tbody> <tr> <td>180° sine:</td> <td>2.3 K/kW</td> </tr> <tr> <td>180° rectangular:</td> <td>3.1 K/kW</td> </tr> <tr> <td>120° rectangular:</td> <td>5.1 K/kW</td> </tr> <tr> <td>60° rectangular:</td> <td>8.7 K/kW</td> </tr> </tbody> </table>	180° sine:	2.3 K/kW	180° rectangular:	3.1 K/kW	120° rectangular:	5.1 K/kW	60° rectangular:	8.7 K/kW	Fig. 2 Dependence transient thermal impedance junction to case on square pulse				
180° sine:	2.3 K/kW												
180° rectangular:	3.1 K/kW												
120° rectangular:	5.1 K/kW												
60° rectangular:	8.7 K/kW												

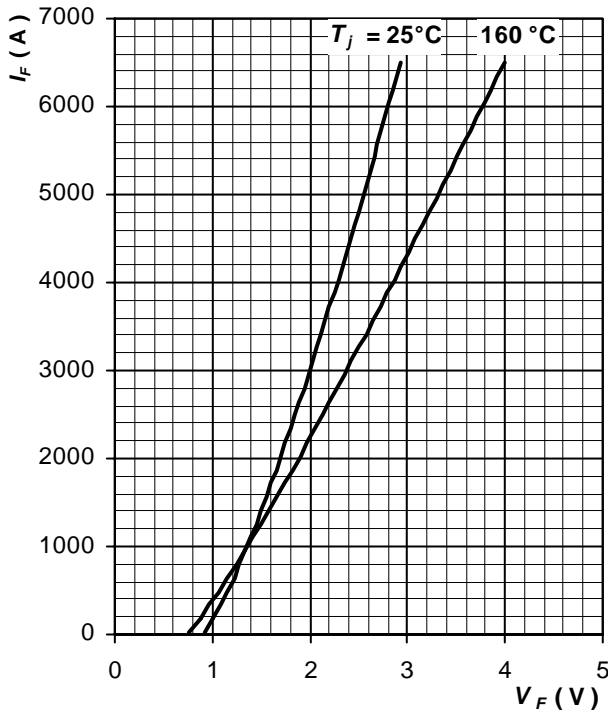

Fig. 3 Maximum forward voltage drop characteristics

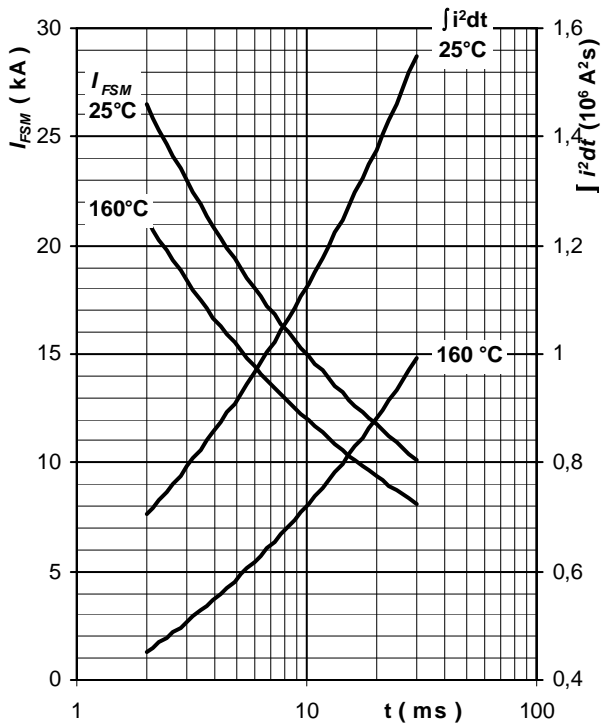

Fig. 4 Surge forward current vs. pulse length, half sine wave, single pulse, $V_R = 0 \text{ V}$

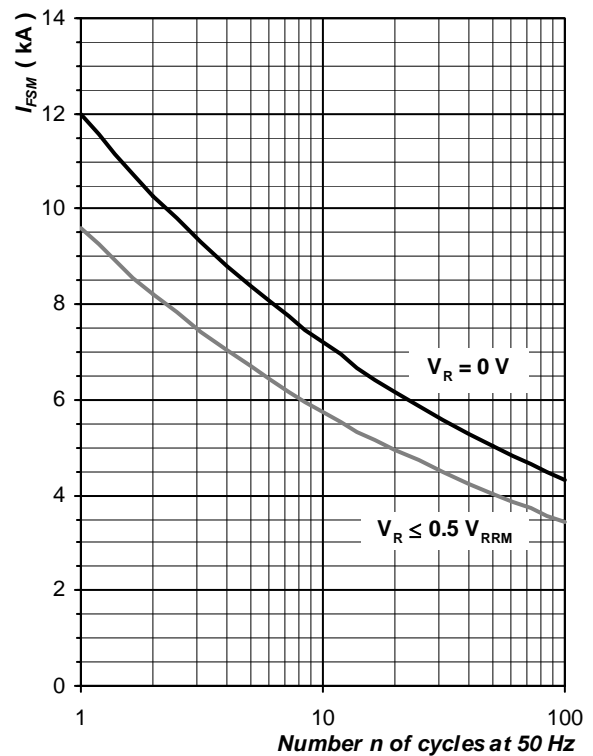

Fig. 5 Surge forward current vs. number of pulses, half sine wave, $T_j = T_{jmax}$

ABB s.r.o., Novodvorska 1768/138a, 142 21 Praha 4, Czech Republic

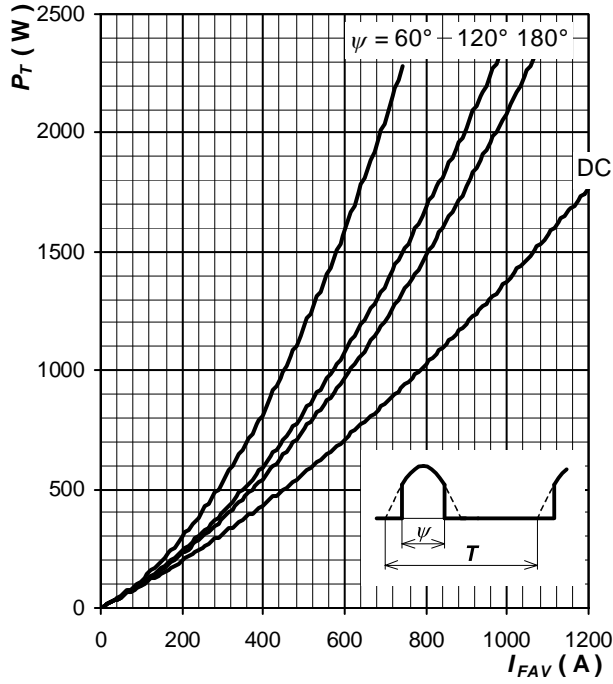

Fig. 6 Forward power loss vs. average forward current, sine waveform, $f = 50 \text{ Hz}$, $T = 1/f$

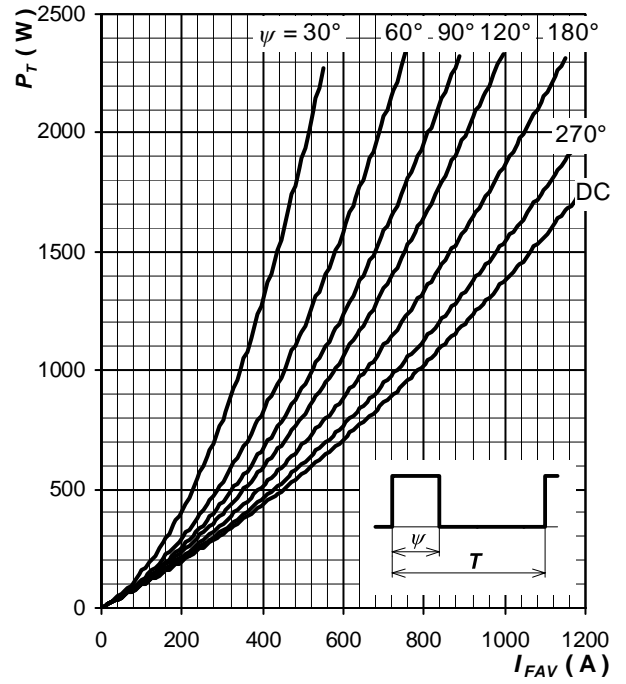

Fig. 7 Forward power loss vs. average forward current, square waveform, $f = 50 \text{ Hz}$, $T = 1/f$

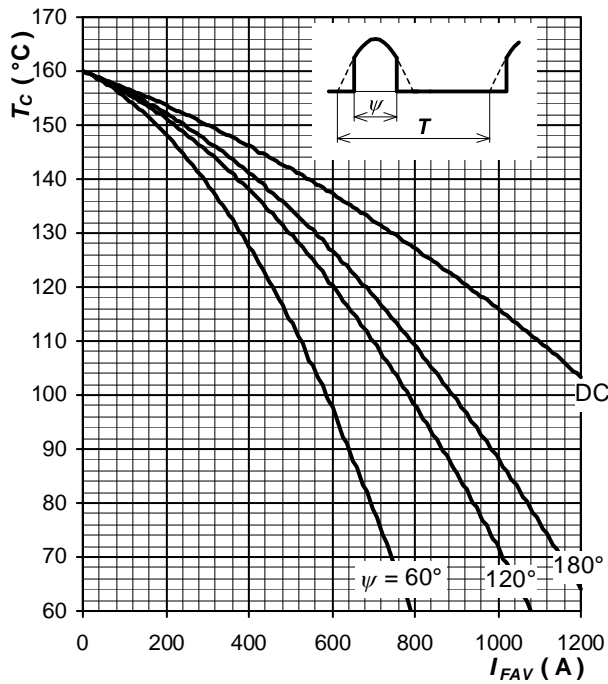

Fig. 8 Max. case temperature vs. aver. forward current, sine waveform, $f = 50 \text{ Hz}$, $T = 1/f$

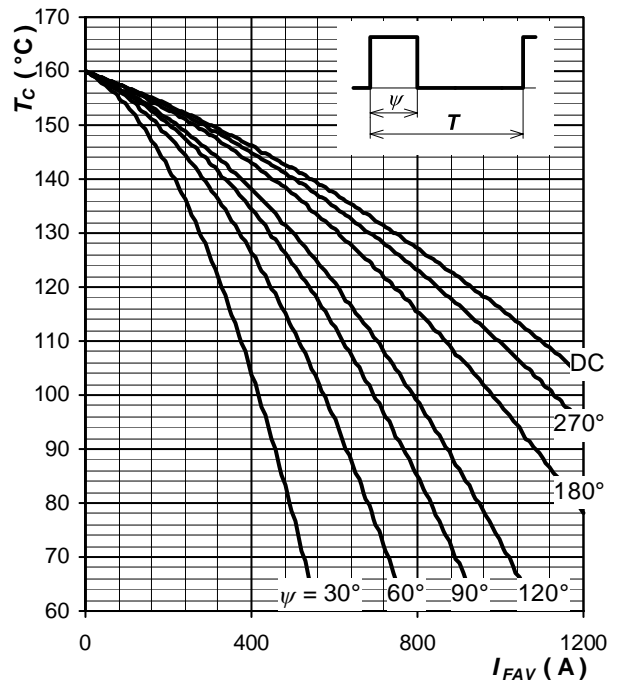

Fig. 9 Max. case temperature vs. aver. forward current, square waveform, $f = 50 \text{ Hz}$, $T = 1/f$

ABB s.r.o., Novodvorska 1768/138a, 142 21 Praha 4, Czech Republic

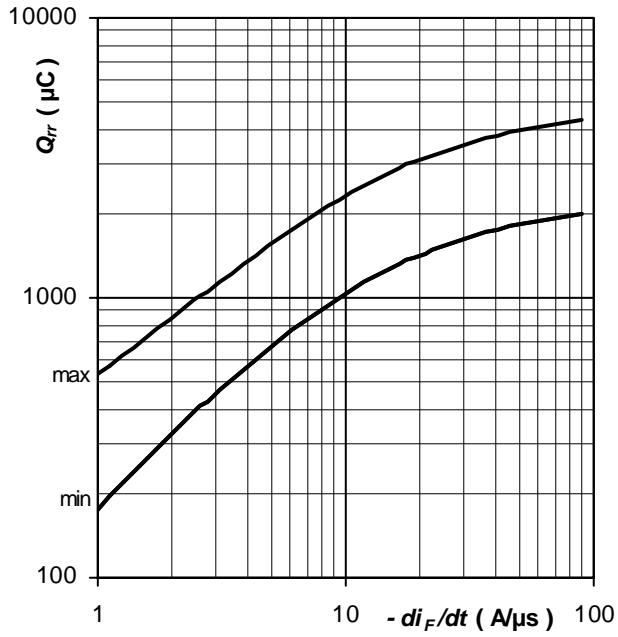

Fig. 10 Recovered charge Q_{rr}
vs. rate of fall forward current di_F/dt ,
trapezoid pulse, $I_{FM} = 1\ 000\ \text{A}$,
 $V_R = 100\ \text{V}$, $T_j = T_{jmax}$

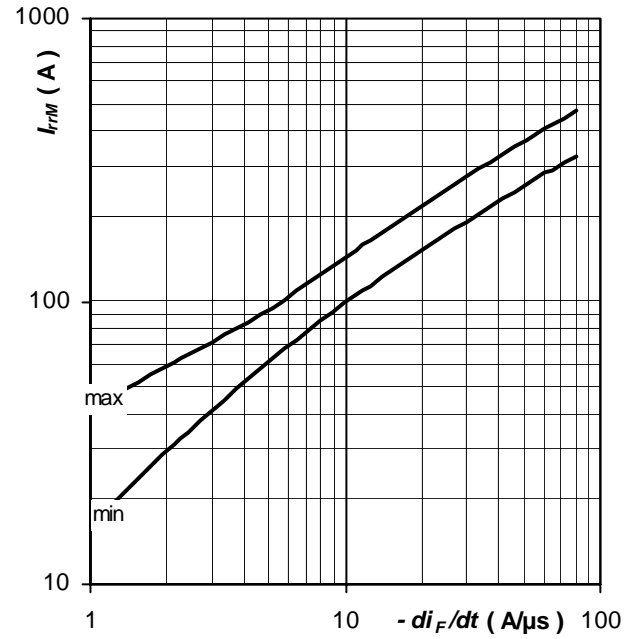

Fig. 11 Reverse recovery maximum current I_{rrM}
vs. rate of fall forward current di_F/dt ,
trapezoid pulse, $I_{FM} = 1\ 000\ \text{A}$,
 $V_R = 100\ \text{V}$, $T_j = T_{jmax}$

Notes: